



Model 6020 | 6021

## 1.5KN TOP AND SIDE MOUNT

- | Quick and simple mounting
- | Different finishes
- | For glass thicknesses between 12 - 21.52 mm
- | Drainage holes
- | Increased stability with the same looks
- | For applications of 0.74 kN in private areas, the mounting distance amounts to 60 cm
- | Private, commercial and public areas

# TL-6020

1.5 kN Top Mount

## Level Up.

The TL-6020 U-profile is the intelligent onward development of the TL-6010 profile. Here the outstanding feature consists in the increase of mounting distances, which now enables the use of the profile also on an anchor bolt without countersunk head. Therefore, mounting the product is not only faster and more cost efficient, but also statics have improved considerably.

It can be used in exterior applications, withstands a linear load of 1.5 kN and is appropriate for glass thicknesses between 12 mm and 21.52 mm.

## Essential Features

- | Slimline, elegant design and low-maintenance
- | ONLEVEL FLEXFIT Glass Adjustment Tool
- | Extension pin holes
- | Drainage holes
- | For use with Top Cover 3.0 kN
- | For glass thicknesses between 12 - 21.52 mm
- | For applications of 0.74 kN in private areas, the mounting distance amounts to 60 cm

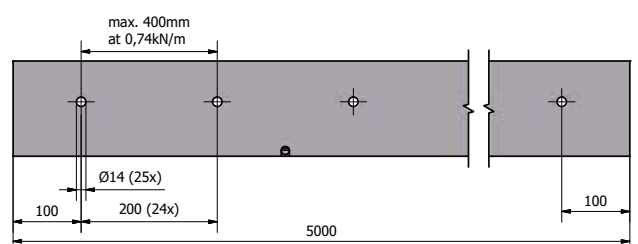
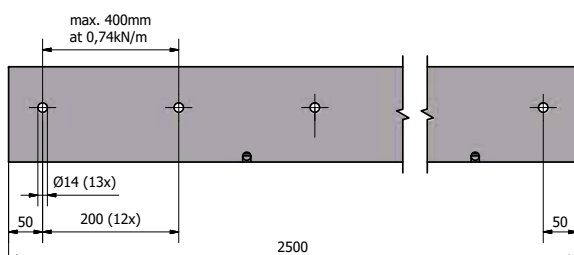
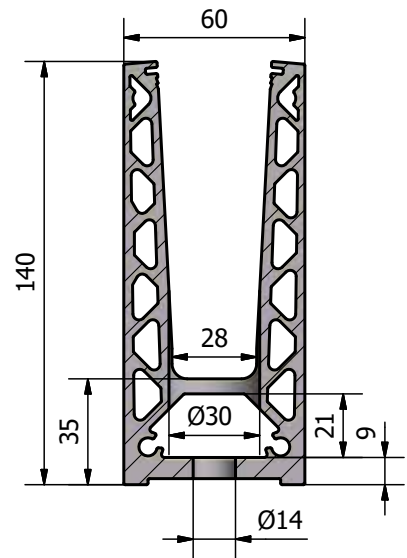
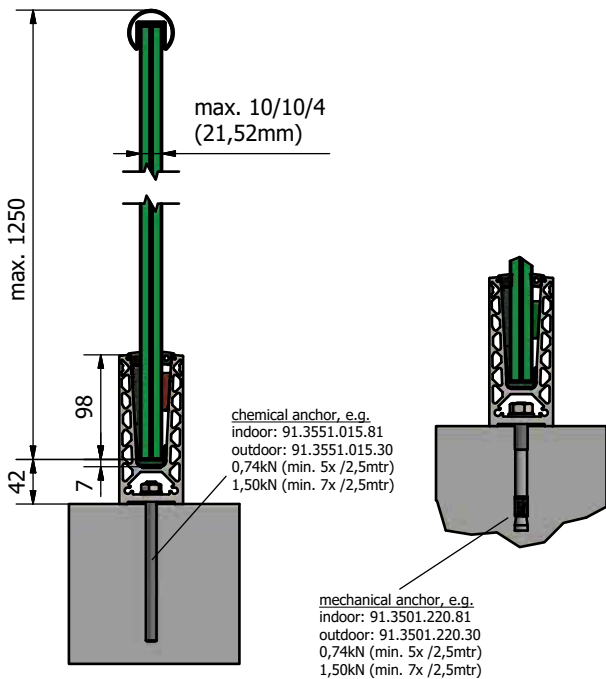
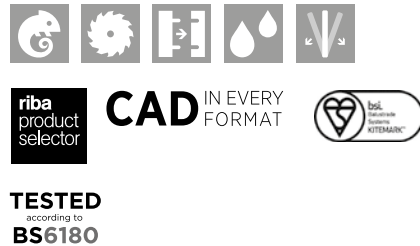



Increased stability with the same looks

Integrated multifunctional sophisticated chamber for enabling larger drilling distances



Top mount

# TL-6020 | 1.5 KN TOP MOUNT

## Glass profile



| Height: 140 mm  
| Width: 60 mm  
| Sales unit: 1 piece

Model 6020	Mill finish	Plain aluminium	RAL coloured
Length	Art. no.	Art. no.	Art. no.
2500	-	10.6020.002.11	-
5000	10.6020.005.10	10.6020.005.11	10.6020.005.13/16/18

## Inside corner / outside corner 90°



| Side length inside: 140 mm  
| Side length outside: 200 mm  
| Sales unit: 1 piece

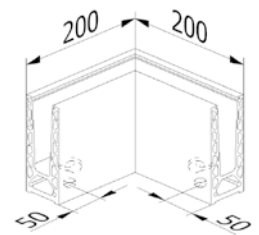

Model 6020	Mill finish	Plain aluminium	RAL coloured
	Art. no.	Art. no.	Art. no.
	10.6020.390.10	10.6020.390.11	10.6020.390.13/16/18

## End cap, left/right



| For use on the left and right  
| Sales unit: 1 piece

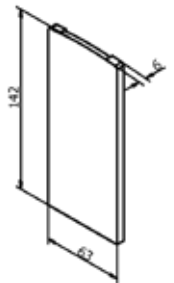

Model 6020	Mill finish	Plain aluminium	RAL coloured
Application	Art. no.	Art. no.	Art. no.
left/right	10.6020.490.10	10.6020.490.11	10.6020.490.13/16/18

## End cap for staircase, left/right



| For use on the left and right  
| cut-to-size  
| Sales unit: 1 piece

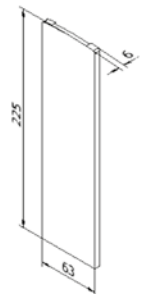

Model 6020	Mill finish	Plain aluminium	RAL coloured
Application	Art. no.	Art. no.	Art. no.
left/right	10.6020.491.10	10.6020.491.11	10.6020.491.13/16/18

# TL-6020 | 1.5 KN TOP MOUNT

## Spacer



You do not have any drainage options on your balcony?!  
So that you do not need to install a dam on your balcony, you can simply mount the spacers beneath your profile.

- | Inner drill hole:  $\varnothing$  14 mm
- | Sales unit: 13 pieces

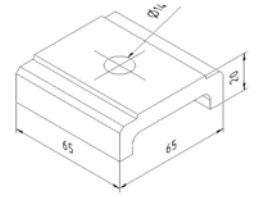

Model 6020	Mill finish	Plain aluminium	RAL coloured
	Art. no.	Art. no.	Art. no.
	10.6020.500.10	10.6020.500.11	10.6020.500.13/16/18

## Extension pin



- | Length: 40 mm
- | Diameter:  $\varnothing$  6 mm
- | Sales unit: 8 piece

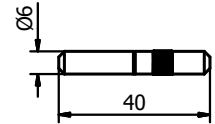

Model 7001	AISI 316 (inside & outside)
	Art. no.
	90.7001.640.31

## Fischer fixing anchor FIS AM M10x150



- | Finish interior application: zinc-plated steel (inside)
- | Finish exterior application: V4A (exterior)
- | Required number per 2500 mm: 13 pieces
- | Suitable mortar: 91.3000.010.00
- | Sales unit: 10 pieces

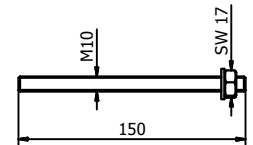

Model 3551	zinc-plated steel (inside)	AISI 316 (exterior)
	Art. no.	Art. no.
	91.3551.015.81	91.3551.015.30

## Fixing anchor steel



- | Finish interior application: zinc-plated steel (inside)
- | Finish exterior application: V4A (exterior)
- | Required number per 2500 mm: 13 pieces
- | M10 x 60 mm
- | Sales unit: 25 pieces

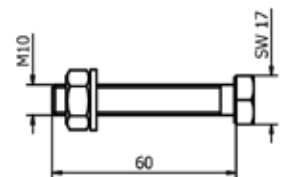

Model 6020	zinc-plated steel (inside)	AISI 316 (exterior)
	Art. no.	Art. no.
	91.6020.060.81	91.6020.060.30

# TL-6020 | 1.5 KN TOP MOUNT

## Fischer fixing anchor FAZ II 12/10



- | Finish interior application: zinc-plated steel (inside)
- | Finish exterior application: V4A (exterior)
- | Required number per 2500 mm: 7 pieces
- | Sales unit: 20 pieces

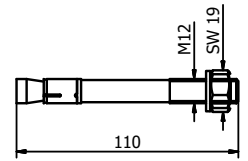

Model 3501	zinc-plated steel (inside)	AISI 316 (exterior)
Art. no.		Art. no.
	91.3501.210.81	91.3501.210.30

## Screw anchor for concrete



- | Suitable for our profiles without countersinking
- | Finish interior application: Zinc-plated steel (interior) HUS3-H 10x90
- | Finish exterior application: V4A (outside) HUS3-HR 10x95
- | Tangential screwdriver required

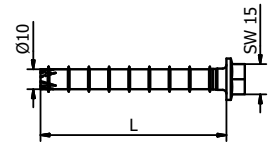

Model 3701	zinc-plated steel (inside)	Model 3701	AISI 316 (exterior)
Sales unit	Art. no.	Sales unit	Art. no.
50	91.3701.090.81	25	91.3701.095.30

## FLEXFIT 1.0 kN



- | Fine adjustment of glass panes
- | For glass thicknesses between 12 - 21.52 mm
- | Adjustment of up to 34 mm in relation to the vertical axis
- | Pay attention to the right glass thickness!

Length		2500 mm	5000 mm	25 mtr
Glass thickness	Wedge colour	Art. no.	Art. no.	Art. no.
12 mm	black	90.0502.112.00	90.0505.112.00	90.0525.112.00
6/6/2 (12.76 mm)	red	90.0502.113.00	90.0505.113.00	90.0525.113.00
6/6/4 (13.52 mm)	grey	90.0502.114.00	90.0505.114.00	90.0525.114.00
15 mm	yellow	90.0502.115.00	90.0505.115.00	90.0525.115.00
<b>8/8/2 (16.76 mm)</b>	red	90.0502.117.00	90.0505.117.00	90.0525.117.00
<b>8/8/4 (17.52 mm)</b>	green	90.0502.118.00	90.0505.118.00	90.0525.118.00
19 mm	blue	90.0502.119.00	90.0505.119.00	90.0525.119.00
<b>10/10/2 (20.76 mm)</b>	red	90.0502.121.00	90.0505.121.00	90.0525.121.00
<b>10/10/4 (21.52 mm)</b>	green	90.0502.122.00	90.0505.122.00	90.0525.122.00

# TAKE A LITTLE DISTANCE – WITH OUR SPACER.

Hoover Dam is a thing of the past. There is more water on balconies than in the legendary dammed Colorado River. We have the suitable spacer for every profile to keep your feet dry. In addition, our spacers are constructed such as to adapt themselves to all static conditions.

---

10.xxxx.500.xx

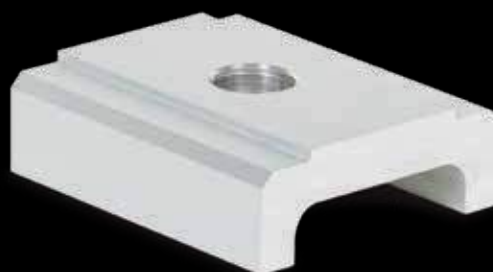

# TL-6021

1.5 kN Side Mount

## The Evolution Goes On.

The TL-6021 U-profile is the intelligent onward development of the TL-6011 profile. Here the outstanding feature consists in the increase of mounting distances, which now enables the use of the profile also on an anchor bolt without countersunk head. This makes mounting the product not only much quicker and more cost efficient, also statics have improved significantly.

The TL-6021 U-profile can be used for exterior applications. It can withstand a linear load of 1.5 kN and is appropriate for glass thicknesses between 12 mm and 21.52 mm.

## Essential Features

- | Slimline, elegant design and low-maintenance
- | ONLEVEL FLEXFIT Glass Adjustment Tool
- | Drainage holes
- | Cover (optional)
- | For use with Top Cover 3.0 kN
- | For glass thicknesses between 12 mm and 21.52 mm
- | For applications of 0.74kN in private areas, the mounting distance amounts to 40 cm

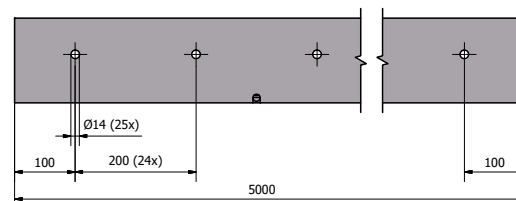
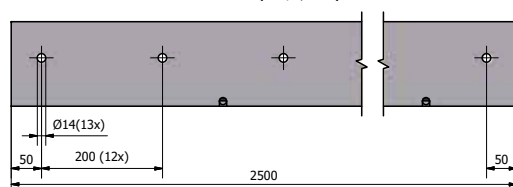
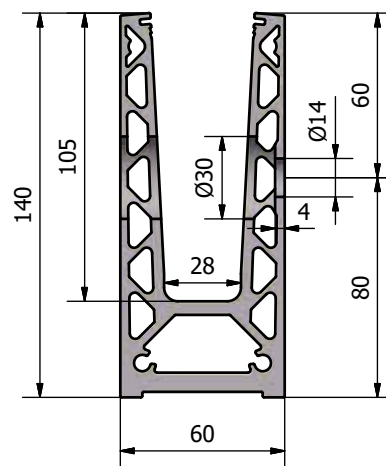
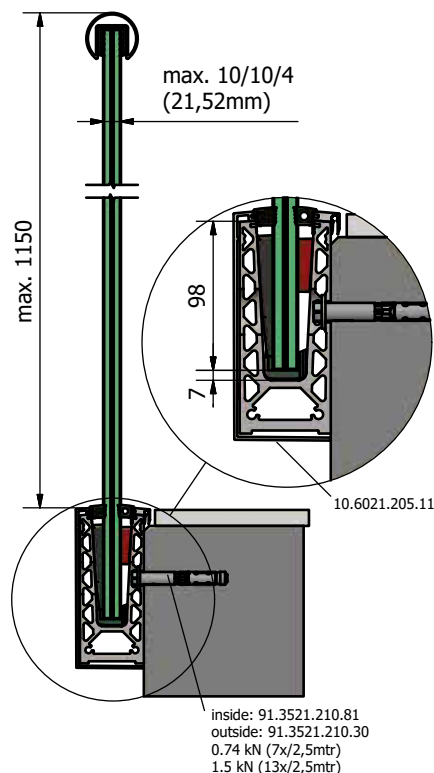
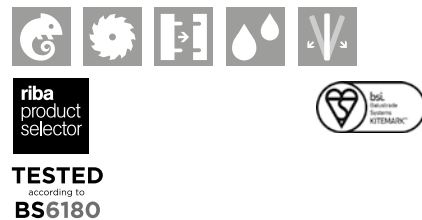





Improved statics

Can be anchored universally depending on the application



Side mount

Integrated multifunctional sophisticated chamber for enabling larger drilling distances

# TL-6021 | 1.5 KN SIDE MOUNT

## Glass profile



| Height: 140 mm  
| Width: 60 mm  
| Sales unit: 1 piece

Model 6021	Mill finish	Plain aluminium	RAL coloured
Length	Art. no.	Art. no.	Art. no.
2500	-	10.6021.002.11	-
5000	10.6021.005.10	10.6021.005.11	10.6021.005.13/16/18

## Inside corner 90°



| Side length inside: 140 mm  
| Side length outside: 200 mm  
| Sales unit: 1 piece

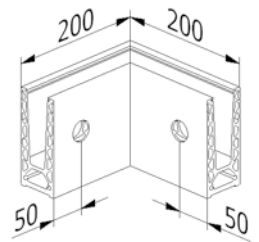

Model 6021	Mill finish	Plain aluminium	RAL coloured
	Art. no.	Art. no.	Art. no.
	10.6021.300.10	10.6021.300.11	10.6021.300.13/16/18

## Outside corner 90°



| Side length inside: 140 mm  
| Side length outside: 200 mm  
| Sales unit: 1 piece

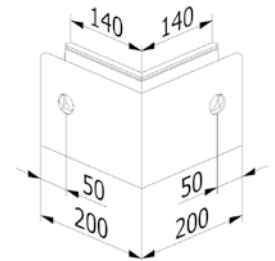

Model 6021	Mill finish	Plain aluminium	RAL coloured
	Art. no.	Art. no.	Art. no.
	10.6021.350.10	10.6021.350.11	10.6021.350.13/16/18

## End cap, left



| For use on the left  
| Sales unit: 1 piece

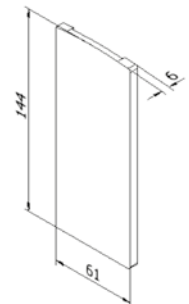

Model 6021	Mill finish	Plain aluminium	RAL coloured
Application	Art. no.	Art. no.	Art. no.
left	10.6021.400.10	10.6021.400.11	10.6021.400.13/16/18

# TL-6021 | 1.5 KN SIDE MOUNT

## End cap, left, with cover cap



| For use on the left  
| Sales unit: 1 piece

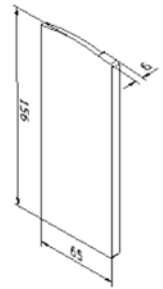

Model 6021	Mill finish	Plain aluminium	RAL coloured
Application	Art. no.	Art. no.	Art. no.
left	10.6021.410.10	10.6021.410.11	10.6021.410.13/16/18

## End cap, right



| For use on the right  
| Sales unit: 1 piece

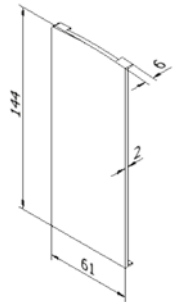

Model 6021	Mill finish	Plain aluminium	RAL coloured
Application	Art. no.	Art. no.	Art. no.
right	10.6021.450.10	10.6021.450.11	10.6021.450.13/16/18

## End cap, right, with cover cap



| For use on the right  
| Sales unit: 1 piece

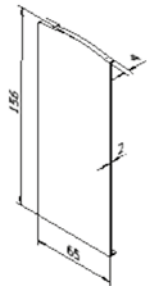

Model 6021	Mill finish	Plain aluminium	RAL coloured
Application	Art. no.	Art. no.	Art. no.
right	10.6021.460.10	10.6021.460.11	10.6021.460.13/16/18

## End cap for staircase with cover strip, left



| For use on the left  
| can be cut to size  
| Sales unit: 1 piece

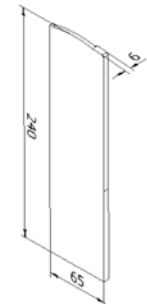

Model 6021	Mill finish	Plain aluminium	RAL coloured
Application	Art. no.	Art. no.	Art. no.
left	10.6021.411.10	10.6021.411.11	10.6021.411.13/16/18

# TL-6021 | 1.5 KN SIDE MOUNT

## End cap for staircase with cover strip, right



| For use on the right  
| can be cut to size  
| Sales unit: 1 piece

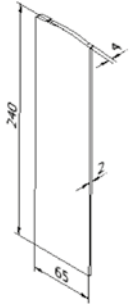

Model 6021	Mill finish	Plain aluminium	RAL coloured
Application	Art. no.	Art. no.	Art. no.
right	10.6021.461.10	10.6021.461.11	10.6021.461.13/16/18

## Cover strip



| With mounting strips  
| For use with a cover cap, end caps must be ordered separately  
| Sales unit: 1 piece



Model 6021	Mill finish	Plain aluminium	RAL coloured
Length	Art. no.	Art. no.	Art. no.
2500	-	10.6021.202.11	-
5000	10.6021.205.10	10.6021.205.11	10.6021.205.13/16/18

## Spacer



| Thickness: 15 mm  
| Sales unit: 1 piece

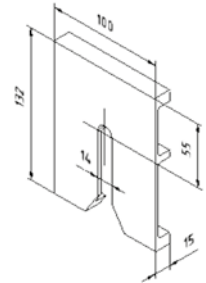

Model 6021	Mill finish	Plain aluminium	RAL coloured
	Art. no.	Art. no.	Art. no.
	10.6021.500.10	10.6021.500.11	10.6021.500.13/16/18

## Blanking plug



| Required number per 2500 mm: 17 pieces  
| Sales unit: 10 pieces

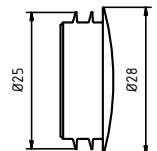

Model 7000	Plastic	
Colour	Diameter	Art. no.
white	30 mm	90.7000.030.40
black	30 mm	90.7000.030.41
grey	30 mm	90.7000.030.45

# TL-6021 | 1.5 KN SIDE MOUNT

## Extension pin



- | Length: 40 mm
- | Diameter: Ø 6 mm
- | Sales unit: 8 piece

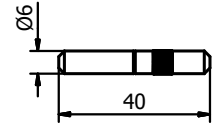

<b>Model 7001</b>	<b>AISI 316 (inside &amp; outside)</b>
Art. no.	
90.7001.640.31	

## Fischer fixing anchor FH II 12/10



- | Finish interior application: zinc-plated steel (inside)
- | Finish exterior application: V4A (exterior)
- | Required number per 2500 mm: 13 pieces
- | Sales unit: 50 pieces

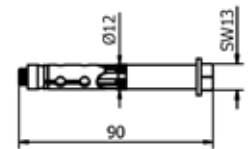

<b>Model 3521</b>	<b>zinc-plated steel (inside)</b>	<b>AISI 316 (exterior)</b>
Art. no.		Art. no.
91.3521.210.81		91.3521.210.30

## Mounting set for steel



- | Finish interior application: zinc-plated steel (inside)
- | Finish exterior application: V4A (exterior)
- | Required number per 2500 mm: 13 pieces
- | M10 x 60 mm
- | Sales unit: 13 pieces

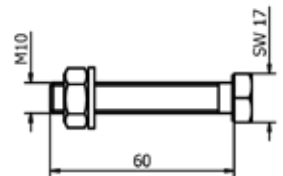

<b>Model 6021</b>	<b>zinc-plated steel (inside)</b>	<b>AISI 316 (exterior)</b>
Art. no.		Art. no.
91.6021.060.81		91.6021.060.30

## Mounting set for wood



- | Finish interior application: zinc-plated steel (inside)
- | Required number per 2500 mm: 13 pieces
- | M12
- | Sales unit: 13 pieces

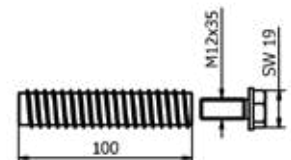

<b>Model 6021</b>	<b>zinc-plated steel (inside)</b>
Art. no.	
91.6021.800.81	



# TL-6021 | 1.5 KN SIDE MOUNT

## Screw anchor for concrete



- | Suitable for our profiles without countersinking
- | Finish interior application: Zinc-plated steel (interior) HUS3-H 10x90
- | Finish exterior application: V4A (outside) HUS3-HR 10x95
- | Tangential screwdriver required

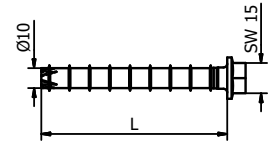

Model 3701		Model 3701	
zinc-plated steel (inside)		AISI 316 (exterior)	
Sales unit	Art. no.	Sales unit	Art. no.
50	91.3701.090.81	25	91.3701.095.30

## FLEXFIT 1.0 KN



- | Fine adjustment of glass panes
- | For glass thicknesses between 12 - 21.52 mm
- | Adjustment of up to 34 mm in relation to the vertical axis
- | Pay attention to the right glass thickness!

Length		2500 mm	5000 mm	25 mtr
Glass thickness	Wedge colour	Art. no.	Art. no.	Art. no.
12 mm	black	90.0502.112.00	90.0505.112.00	90.0525.112.00
6/6/2 (12.76 mm)	red	90.0502.113.00	90.0505.113.00	90.0525.113.00
6/6/4 (13.52 mm)	grey	90.0502.114.00	90.0505.114.00	90.0525.114.00
15 mm	yellow	90.0502.115.00	90.0505.115.00	90.0525.115.00
<b>8/8/2 (16.76 mm)</b>	red	90.0502.117.00	90.0505.117.00	90.0525.117.00
<b>8/8/4 (17.52 mm)</b>	green	90.0502.118.00	90.0505.118.00	90.0525.118.00
19 mm	blue	90.0502.119.00	90.0505.119.00	90.0525.119.00
<b>10/10/2 (20.76 mm)</b>	red	90.0502.121.00	90.0505.121.00	90.0525.121.00
<b>10/10/4 (21.52 mm)</b>	green	90.0502.122.00	90.0505.122.00	90.0525.122.00

# TOP COVER 3.0 KN

## 3.0 kN Top Cover, 3 mm



- | Width 2 mm
- | 3.0 kN, and for the 6020 and 6021 profiles
- | Sales unit: 1 piece



Model 8030	Mill finish	Plain aluminium	RAL coloured
Length	Art. no.	Art. no.	Art. no.
5000	90.8030.035.10	90.8030.035.11	90.8030.035.13/16/18

## 3.0 kN Top Cover, 10 mm



- | Width 8 mm
- | 3.0 kN, and for the 6020 and 6021 profiles
- | Sales unit: 1 piece



Model 8030	Mill finish	Plain aluminium	RAL coloured
Length	Art. no.	Art. no.	Art. no.
5000	90.8030.105.10	90.8030.105.11	90.8030.105.13/16/18

## 3.0 kN Top Cover, 20 mm



- | Width 18 mm
- | 3.0 kN, and for the 6020 and 6021 profiles
- | Sales unit: 1 piece



Model 8030	Mill finish	Plain aluminium	RAL coloured
Length	Art. no.	Art. no.	Art. no.
5000	90.8030.205.10	90.8030.205.11	90.8030.205.13/16/18

## 3.0 kN Top Cover horizontal 2 mm



- | Width 2 mm
- | 3.0 kN
- | e.g. for steel sheets
- | Sales unit: 1 piece



Model 8310	Mill finish	Plain aluminium	RAL coloured
Length	Art. no.	Art. no.	Art. no.
5000	90.8330.025.10	90.8330.025.11	90.8330.025.13/16/18

# ONLEVEL

8, Alexandria Court  
Ashton Commerce Park  
Ashton-under-Lyne  
Lancashire OL7 0QN  
United Kingdom

T +44 0161 804 9500  
F +44 0161 804 9505

[info@onlevel.com](mailto:info@onlevel.com)  
[www.onlevel.com](http://www.onlevel.com)